



ZT 18 - 28  
ZP 18 - 28  
NKLT 22 - 28 - 48  
NKLP 22 - 28 - 48





## PUNTATRIZ DE COLUMNA CON BRAZO PIVOTANTE

## ROCKER ARM SPOT WELDERS

Las puntatrices a puntos de las series Z y NKL, versátiles, robustas, simples de usar, garantizan la óptima soldadura de todos los metales soldables y representan la solución ideal para la mayoría de variadas aplicaciones de soldadura por puntos.

Los modelos Z y NKL vienen provistos de accionamiento mecánico o neumático. ZT y NKLT: accionamiento mecánico a pedal; ZP y NKLP: accionamiento neumático a través pedal eléctrico.

The Z - NKL series resistance spot welders, versatile, robust and easy-to-use, ensure best welding results on any weldable metal and are the most ideal solution for all spot welding applications.

Z-NKL models are supplied either mechanical or air operated. ZT's - NKLT's: mechanically operated pedal. ZP's - NKLP's: pneumatically operated by electric pedal.

### SERIE Z

- Brazo extraíble y regulable en longitud

### SERIE NKL

- Brazo inferior orientable
- Brazo inferior regulable en altura

### Z SERIES

- Arms with adjustable length

### NKL SERIES

- Lower arm lateral adjustment
- Lower arm with adjustable height

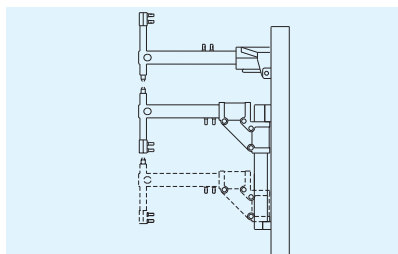
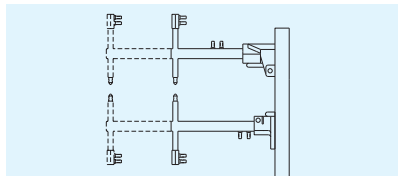

welding together

## CARACTERÍSTICAS

- Óptimas características de soldadura con todos los tipos de metales soldables
- Regulación electrónica de la corriente y del tiempo de soldadura
- Grupo SCR con encendido sincrónico a control de fase, para eliminar las puntas de entrada de corriente
- Absorción reducida
- Brazos refrigerados por agua
- Portaelectrodos de cobre refrigerados por agua y regulables en sentido vertical
- Componentes neumáticos autolubricados para eliminar residuos oleosos y para preservar el ambiente de contaminaciones (ZP - NKLP)
- Elevada versatilidad de uso gracias a las diversas configuraciones de trabajo posibles

- Brazo inferior regulable en altura, giratorio para utilizar con portaelectrodos más largos (Opcional NKL)

- Fuerza entre electrodos regulable mediante presión del muelle y para ZP-NKLP también por regulador de presión del aire dotado con manómetro
- Fácil regulación de la apertura de los electrodos sin sacar el portaelectrodo

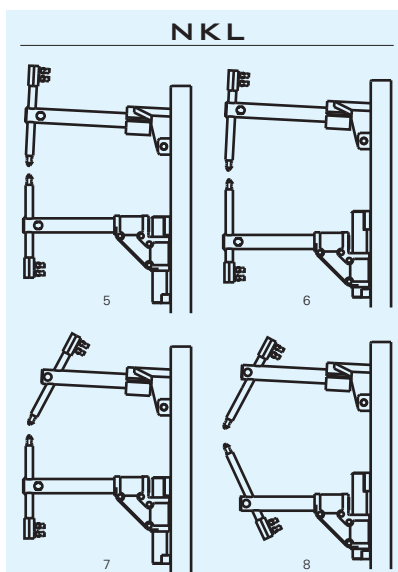
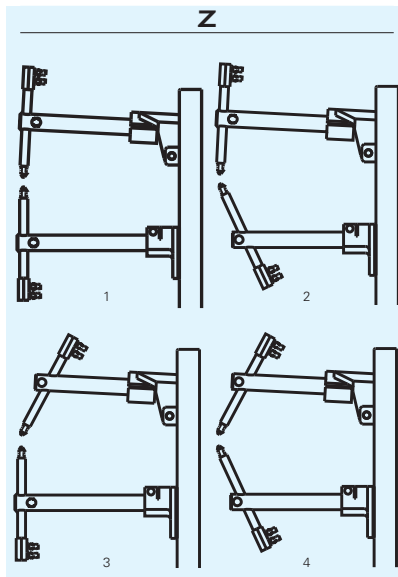

## OPTIONAL

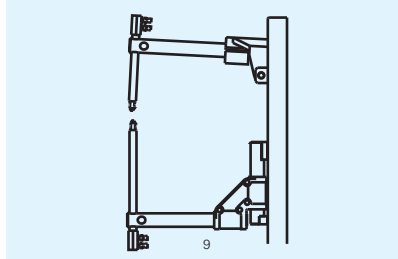

## FEATURES

- Excellent welding on all weldable metals
- Electronic adjustment of the welding current and time
- Synchronous ignition SCR group with phase shift welding current adjustment to eliminate initial transient
- Reduced consumption
- Water cooled arms
- Water cooled copper electrodeholders with adjustable height
- Self-lubricated pneumatic components to eliminate oil deposits and to safeguard the environment from contaminants (ZP-NKLP)
- High versatility thanks to all different possible work configurations

- Lower arm with adjustable height which can be rotated for use with a longer electrodeholder (Optional NKL)

- Electrode force adjustable by spring nut and for ZP's and NKLP's also by air pressure regulation manometer
- Easy electrode gap adjustment without moving the electrodeholders

■ Brazo inferior orientable (NKL)



■ Laterally adjustable lower arm (NKL)

# Z-NKL

Procesos: Soldadura por puntos / Process: Spot Welding

### VERSION ESPECIAL

Brazo inferior con electrodo clavado y portaelectrodo largo en el brazo superior (Opcional).

La profundidad útil resultante es la diferencia aritmética entre A y C (Ver tabla inferior).

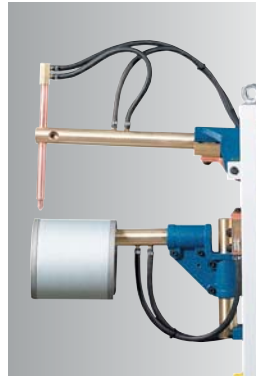
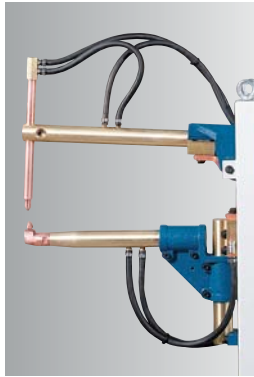

### SPECIAL VERSION

Lower arm with pressed-in electrode and long electrode holder on the upper arm (Optional).

The usable arms depth is given by the difference between A and C (see below table).

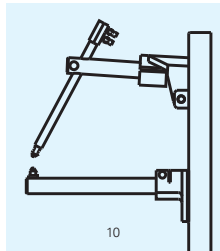

10

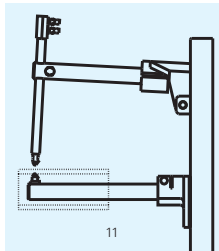

11

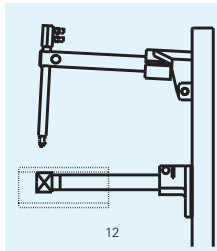

12

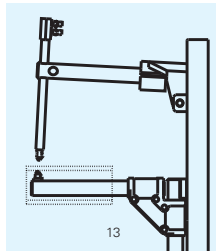

13

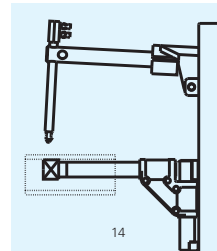

14

10 - 11 - 12 ZT - ZP Optional

13 - 14 NKLT - NKLP Optional



	ZT - ZP	NKLT - NKLP		ZT - ZP		NKLT - NKLP			
				1B	2B	22	28	4B	
A	MIN.	mm		250	250	-	-	-	
	MAX.	mm		600	600	455	455	490	
A (Optional)		mm		-	-	600	600	700	
		mm		-	-	800	800	1000	
B	MIN.	mm		215	215	173	168	163	
	MAX.	mm		-	-	410	443	438	
C		mm		135	135	255	255	285	
				Ø mm	40	40	40	45	50
				Ø mm	21	21	21	21	25
				Ø mm	16	16	16	16	16
					10%	10%	10%	10%	10%

welding together



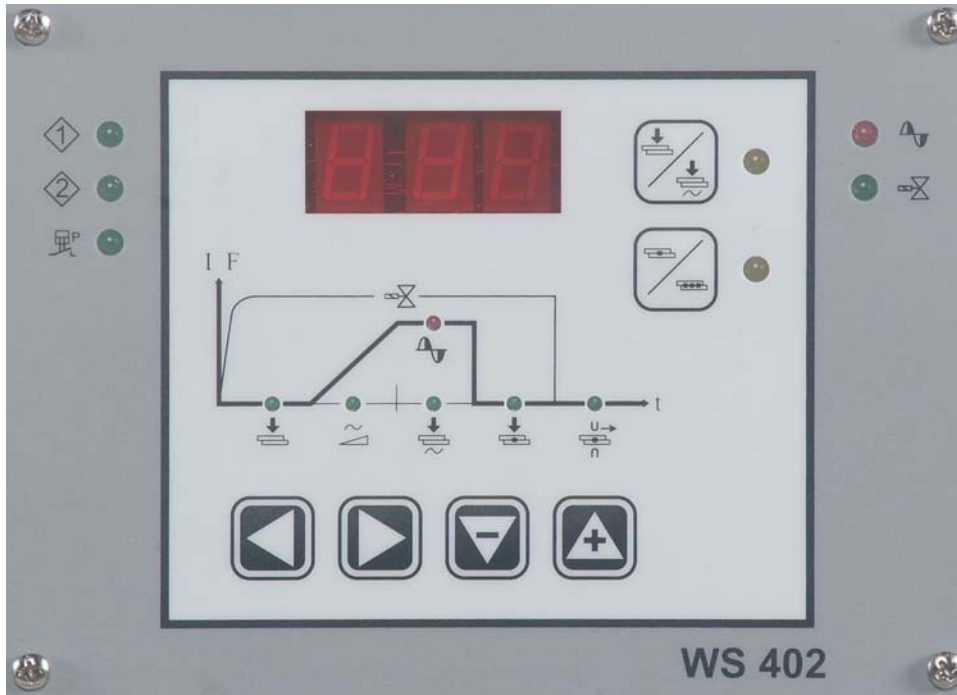

### WS 402

- Tiempo de soldadura programable en periodos
- Modalidad de uso con punto simple o repetición
- Compensación automática de la fluctuación de la tensión de red
- Indicación de mensajes de error durante el ciclo de soldadura
- Pulsador conmutador suelda/no suelda
- Alimentación electroválvula 24 V CC
- Reconocimiento automático frecuencia 50/60 Hz
- Alimentación del control a 24 V CA
- Dos programas de soldadura (2 tiempos y 2 corrientes) seleccionables por medio de doble pedal (optional).

### WS 402

- *Welding time adjustable by periods*
- *Single and repeated spotting facility*
- *Automatic adjustment of mains voltage fluctuation*
- *Error display during the welding cycle*
- *Weld/no weld selector key*
- *24 V DC supply solenoid valve*
- *50/60 Hz frequency automatic identification*
- *24 V AC supply electronic control*
- *2 welding programs (2 times and 2 currents) by using double pedal (optional)*

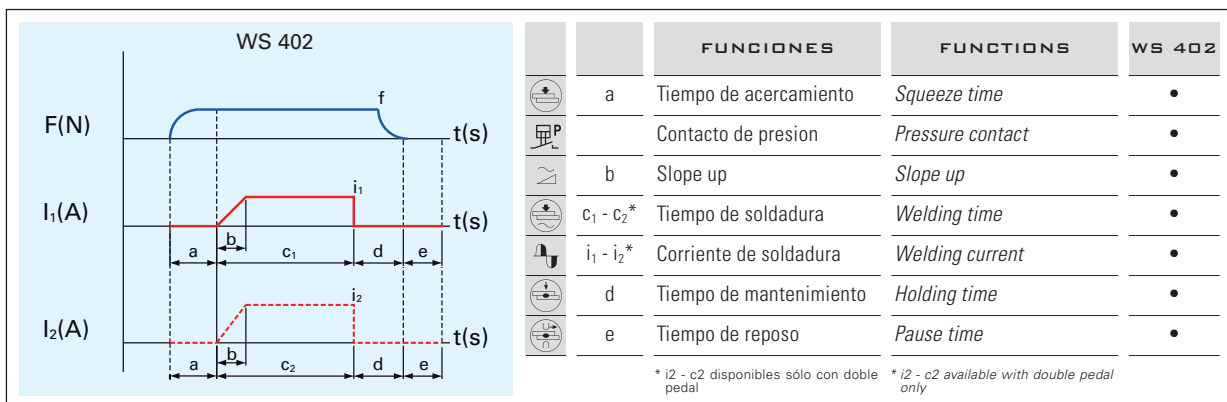

DATOS TECNICOS		TECHNICAL DATA		ZT 18	ZT 28	NKLT 22	NKLT 28	NKLT 48
				ZP 18	ZP 28	NKLP 22	NKLP 28	NKLP 48
	Alimentación monofásica 50/60 Hz	Single phase input 50/60 Hz		U <sub>1</sub>	V	400	400	400
	Potencia nominal máxima	Nominal maximum power		S <sub>nmax.</sub>	kVA	15	25	45
	Potencia máxima de soldadura	Max. welding power		S <sub>max.</sub>	kVA	23	41,6	75
	Potencia de instalación	Installed power		P <sub>1</sub>	kVA	11	14	24
	Sección de cable de conexión	Cross section connecting cables			mm <sup>2</sup>	10	10	16
	Fusible (fusión lenta)	Fuse (delayed action)			A	32	40	63
	Tensión secundaria	Secondary voltage		U <sub>20</sub>	V	2,6	3,5	5,2
	Corriente secundaria de C.C.	Secondary short circuit current		I <sub>2CC</sub>	kA	10,2	13,8	17,8
	Corriente máxima de soldadura	Max. welding current		I <sub>max.</sub>	kA	8,2	11	14,2
	Fuerza entre electrodos 600 kPa (6 bar)	Electrode force at 600 kPa (6 bar)		F <sub>max.</sub>	da N	220	220	260
	Consumo de agua 300 kPa (3 bar)	Water consumption at 300 kPa (3 bar)			l/min	3,8	3,8	3,8
	Dimensiones	Dimensions			mm	760	760	980
					mm	330	330	330
					mm	1200	1200	1200
	Peso	Weight		m	kg	102	116	192

\* Bajo demanda tensiones especiales

\* Other voltages available on request



LOS DATOS SE REFIEREN A PUNTATRICES CON ESCOTE DE BRAZOS MÍNIMO (Z) O ESTÁNDAR (NKL).

LAS CARACTERÍSTICAS TÉCNICAS PUEDEN SUFRIR MODIFICACIONES SIN PREVIO AVISO.

TECHNICAL DATA ARE REFERRED TO SPOT WELDERS HAVING SHORTEST ARMS LENGTH (Z'S) OR MINIMUM THROAT DEPTH AND STANDARD ARMS (NKL'S).

TECHNICAL FEATURES MIGHT CHANGE WITHOUT NOTICE.

## ACCESORIOS

- Equipo de refrigeración IR14 (solo para serie Z 18 o 28 y NKL 22)
- Juego de electrodos de pipa con distancia 65 mm
- Juego de portarregles con regla de 100 mm
- Electrodo especiales (bajo demanda)
- Portaelectrodos largo
- Posibilidad de utilización del pedal de dos etapas: acercamiento y soldadura después de verificar el posicionamiento de la pieza
- Posibilidad de utilizar el doble pedal para la selección y ejecución rápida de dos programas de soldadura

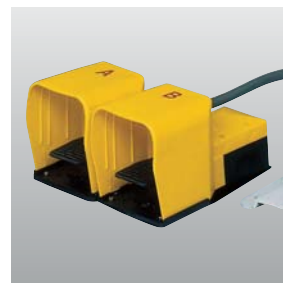
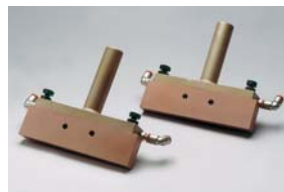

## ACCESSORIES

- IR 14 cooling equipment (only for Z 18 - 28 series and NKL 22)
- 65 mm depth pipe tips set
- Barholders with 100 mm bars
- Special electrodes upon request
- Long electrodeholder
- Possibility of a two step pedal: squeeze and welding only after workpiece position checking
- Possibility of a double pedal for a quick selection and use of two different welding programs

